

General Specification				
Type	OBT-121	OBT-123	OBT-125	OBT-127
Frequency Response	100-20KHZ			
Sensitivity	88±3DB	89±3DB	90±3DB	91±3DB
Power Handling	10W	20W	30W	40W
Power Taps	5W/10W	10W/20W	15W/30W	20W/40W
Line input	100V			
Dimension(L*W*H)	270*151*125	390*151*125	505*151*125	620*151*125
Physical Specification				
Material	Aluminium			
Grille	Power Coated Iron Mesh			
Component	4" Full Range Speaker			
Component	1.5" Mylar			
Finished Colour	Gray			
Unit Weight	1.8Kg	2.9Kg	3.9Kg	4.85Kg
Gross Weight	5kg/2pcs	7kg/2pcs	8.9kg/2pcs	10.5kg/2pcs
Packing Dimension	33*29*16	41*32*16	53*32*16	65*32*16
Speaker Specification				
Voice Coil Size	Φ 0.12*2Layer			
DC Impedance	7.2 Ω			
Former	Kapton			
Magnet	Ferrite(197g) Φ 70* Φ 32*10(Y30)			
Basket	Iron			
Cone Material	Paper Coat			
Spider	Cloth			
Dust cap	Mylar			
Net Weight	400g			

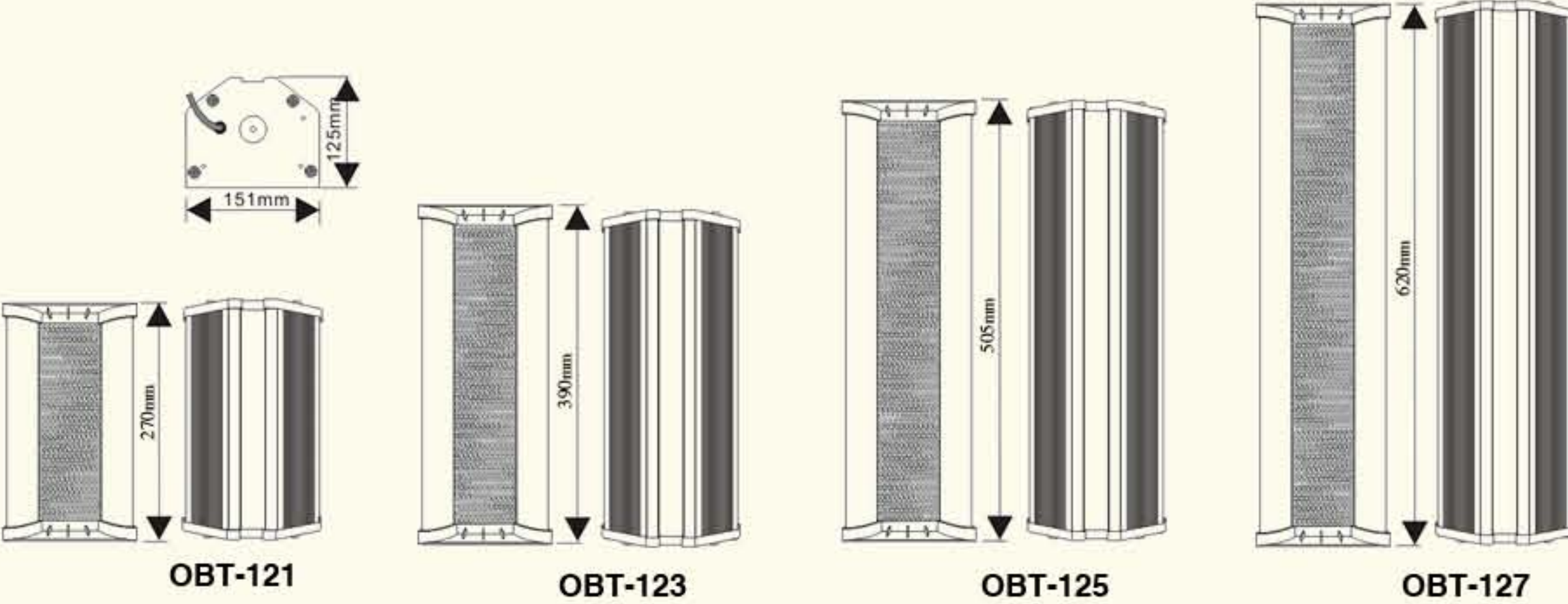

OBT-121

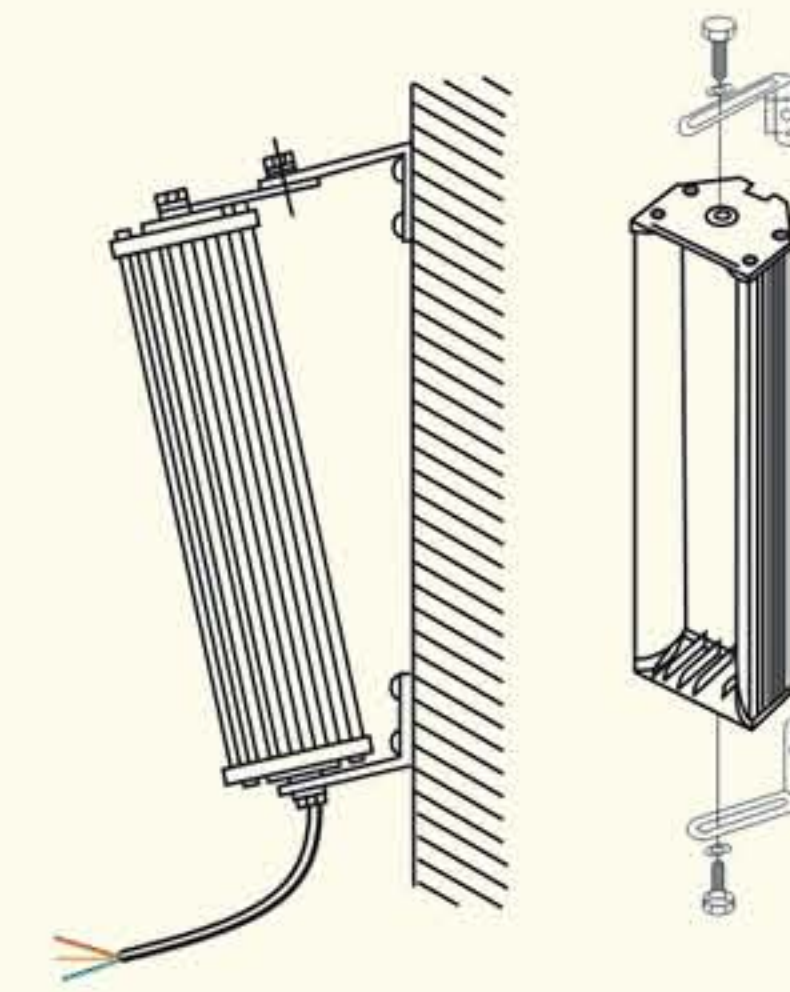
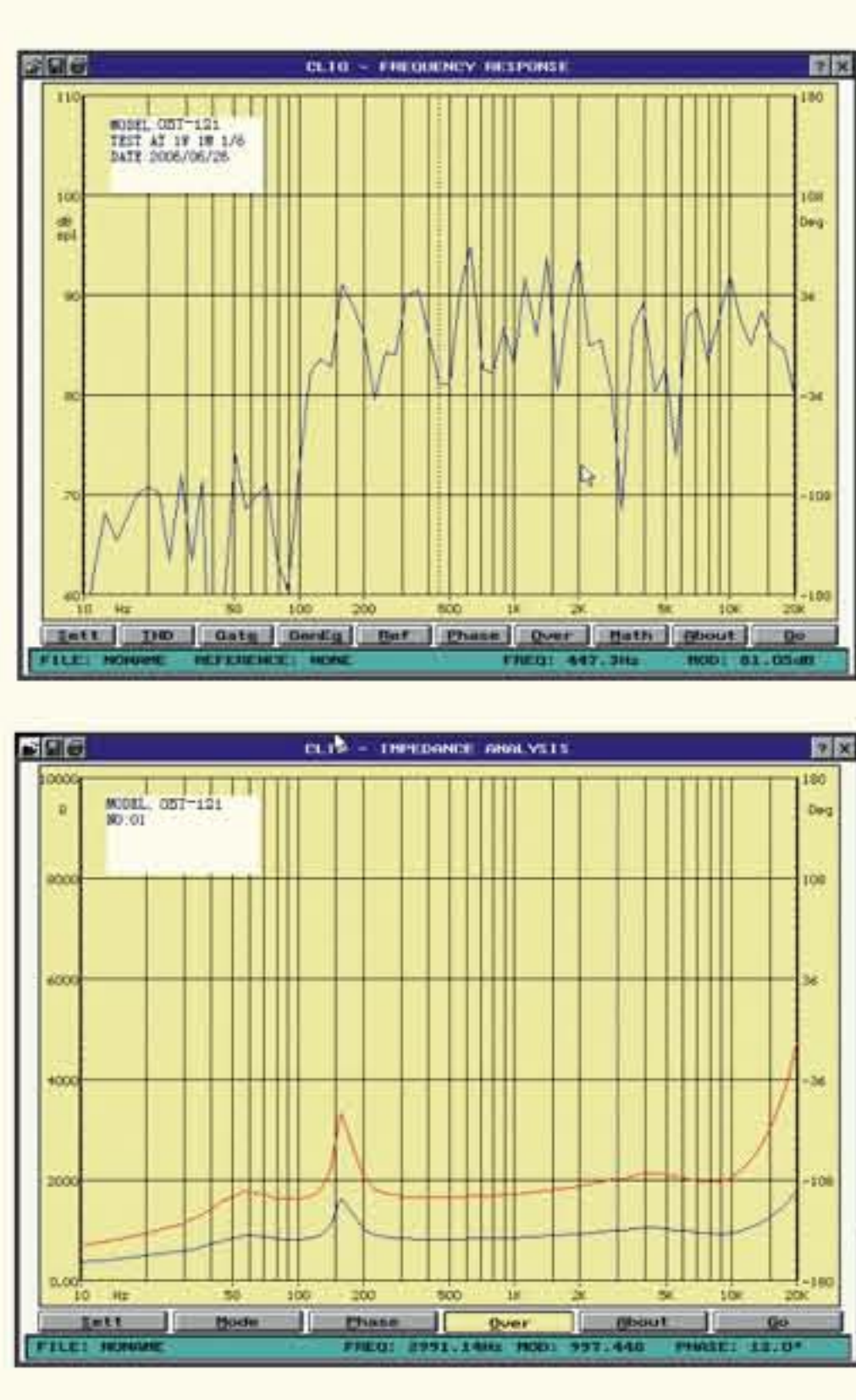

Horizontal

Vertical

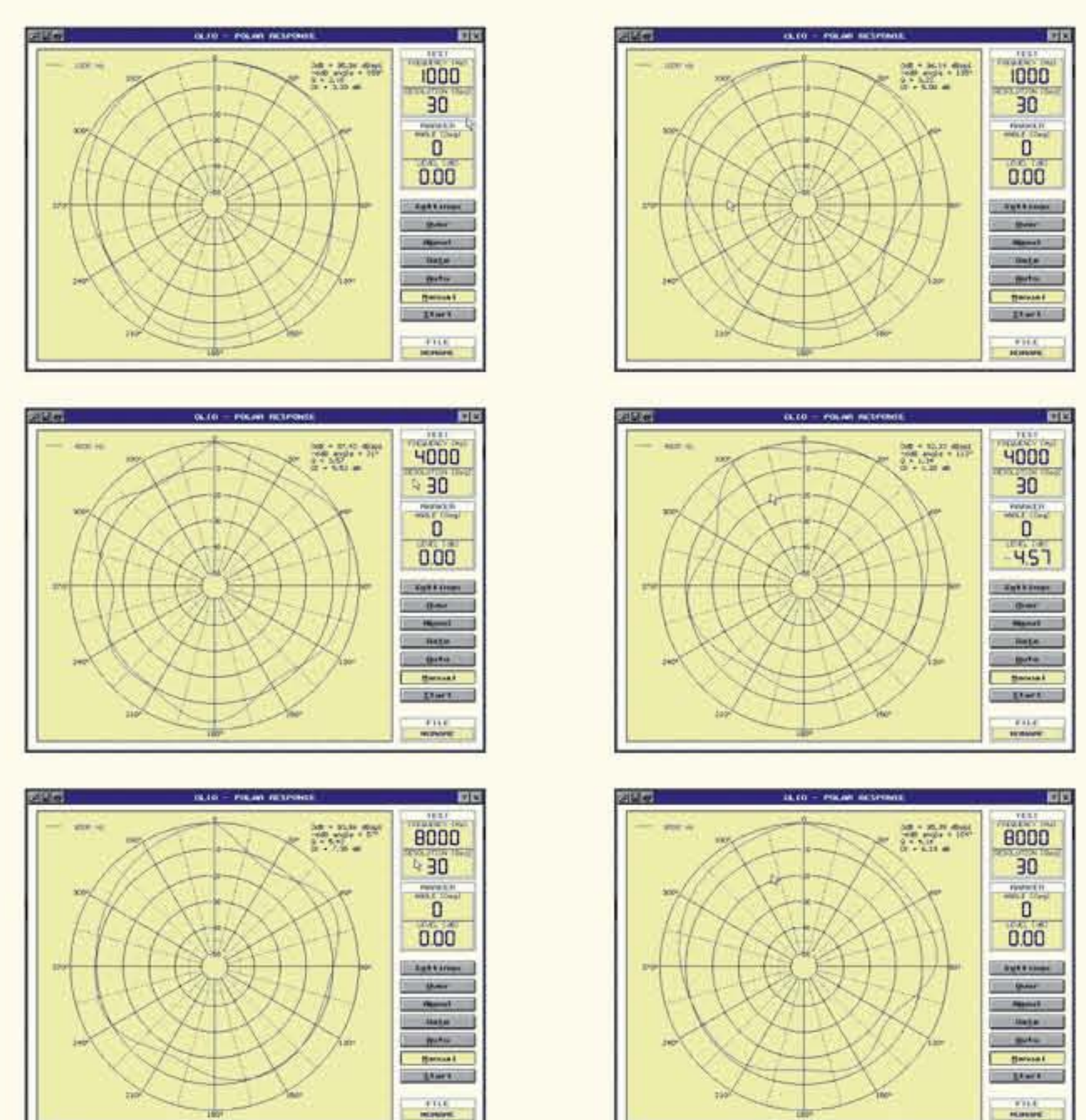

OBT-123

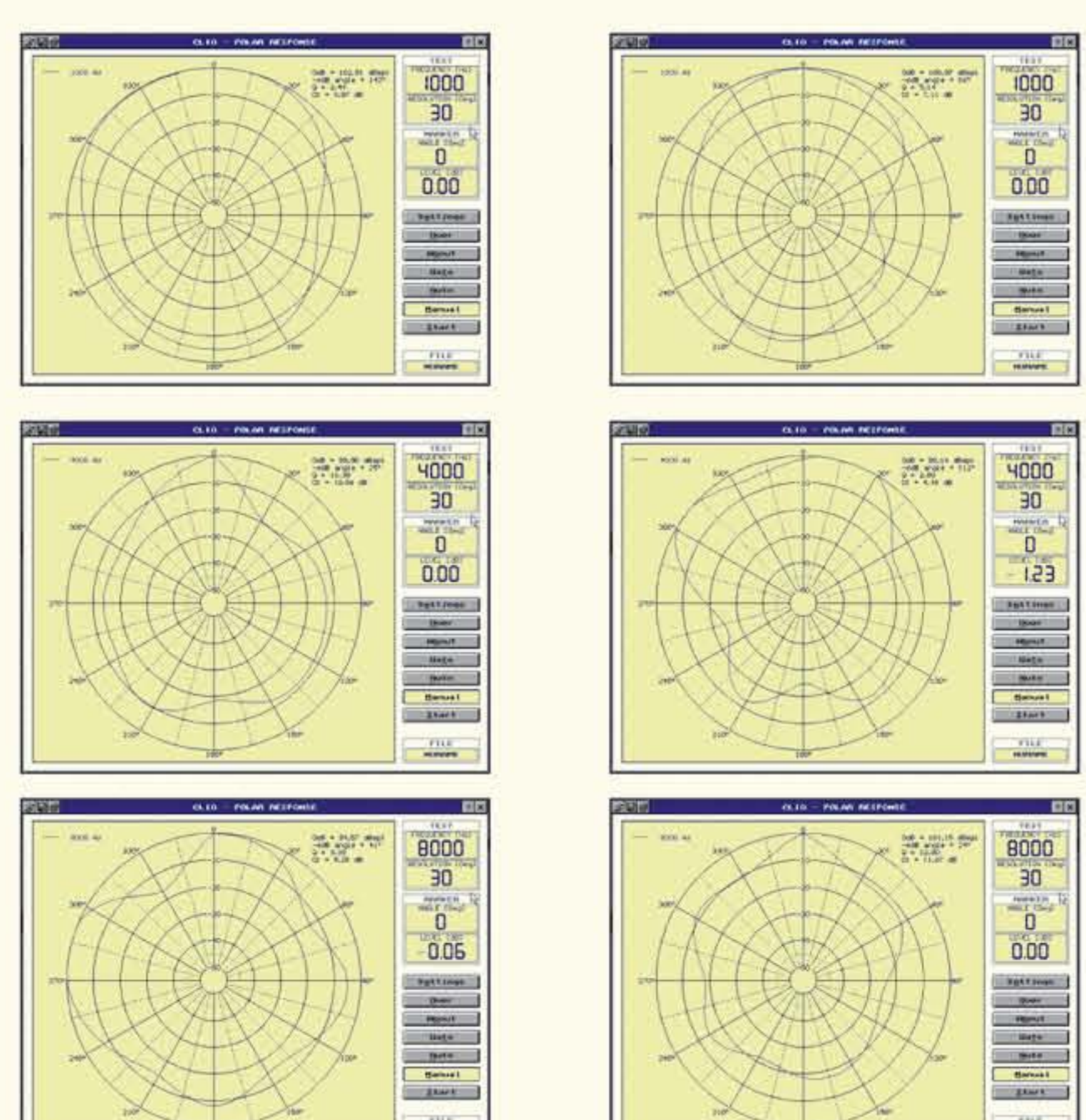
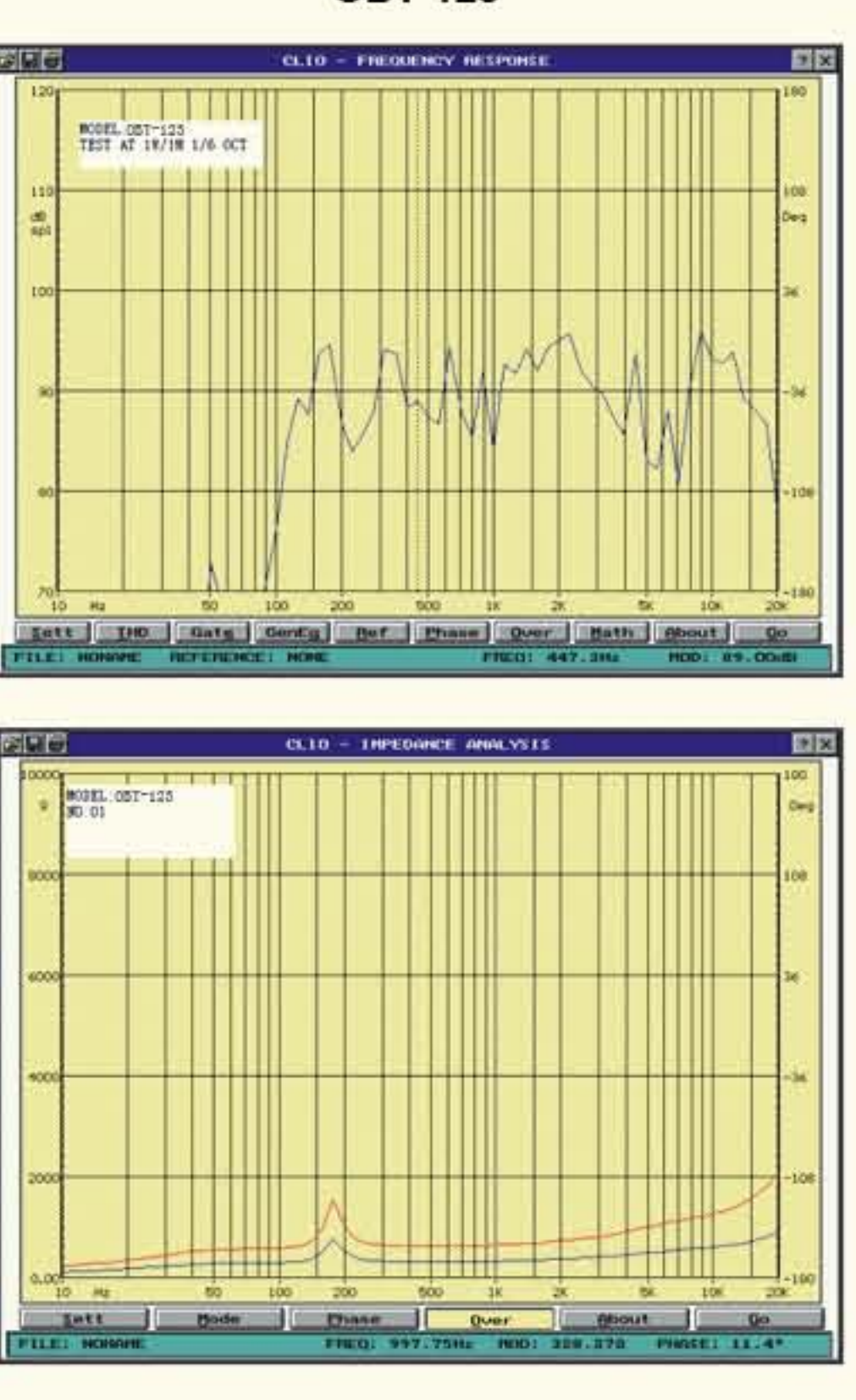

OBT-125

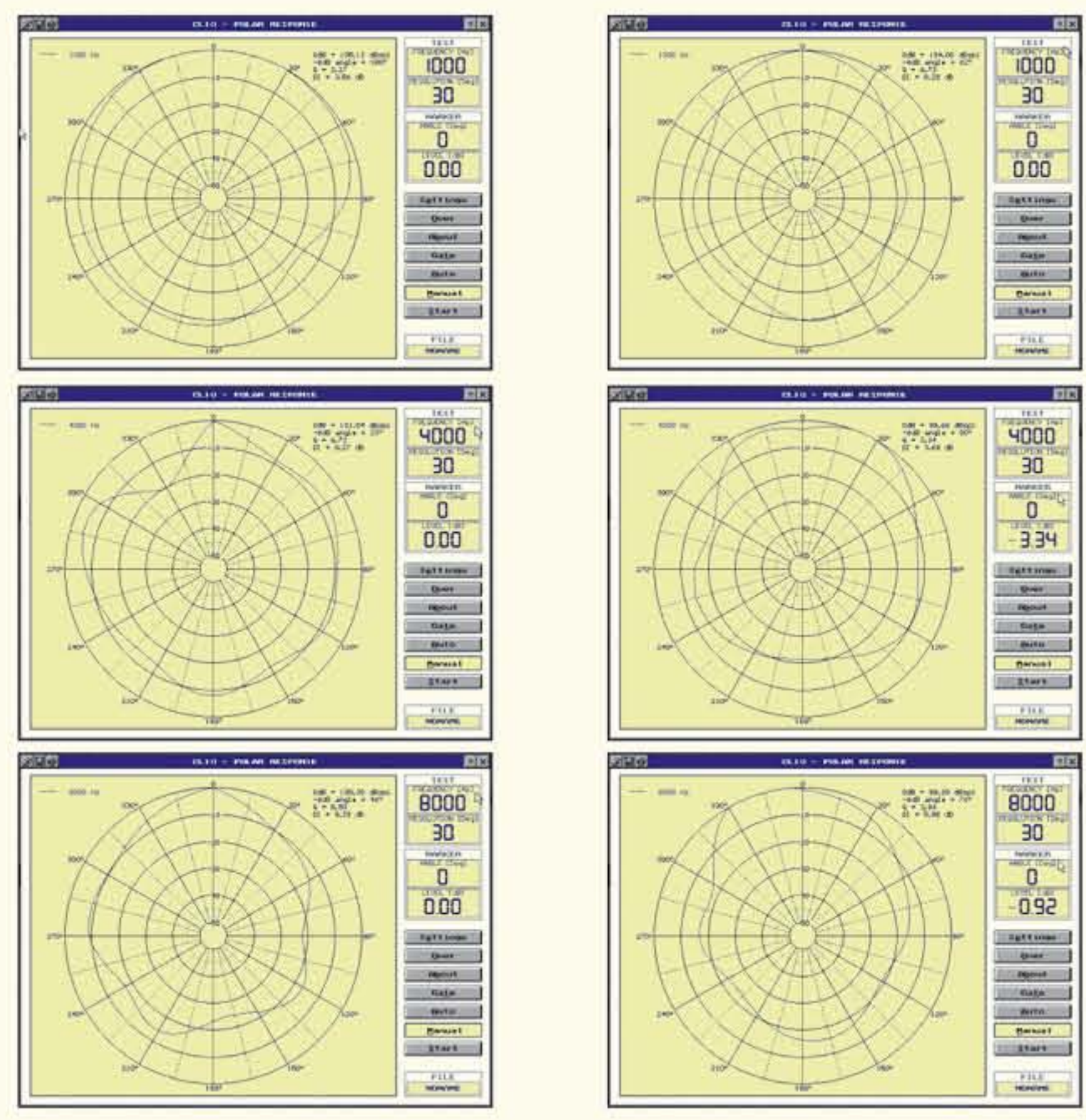
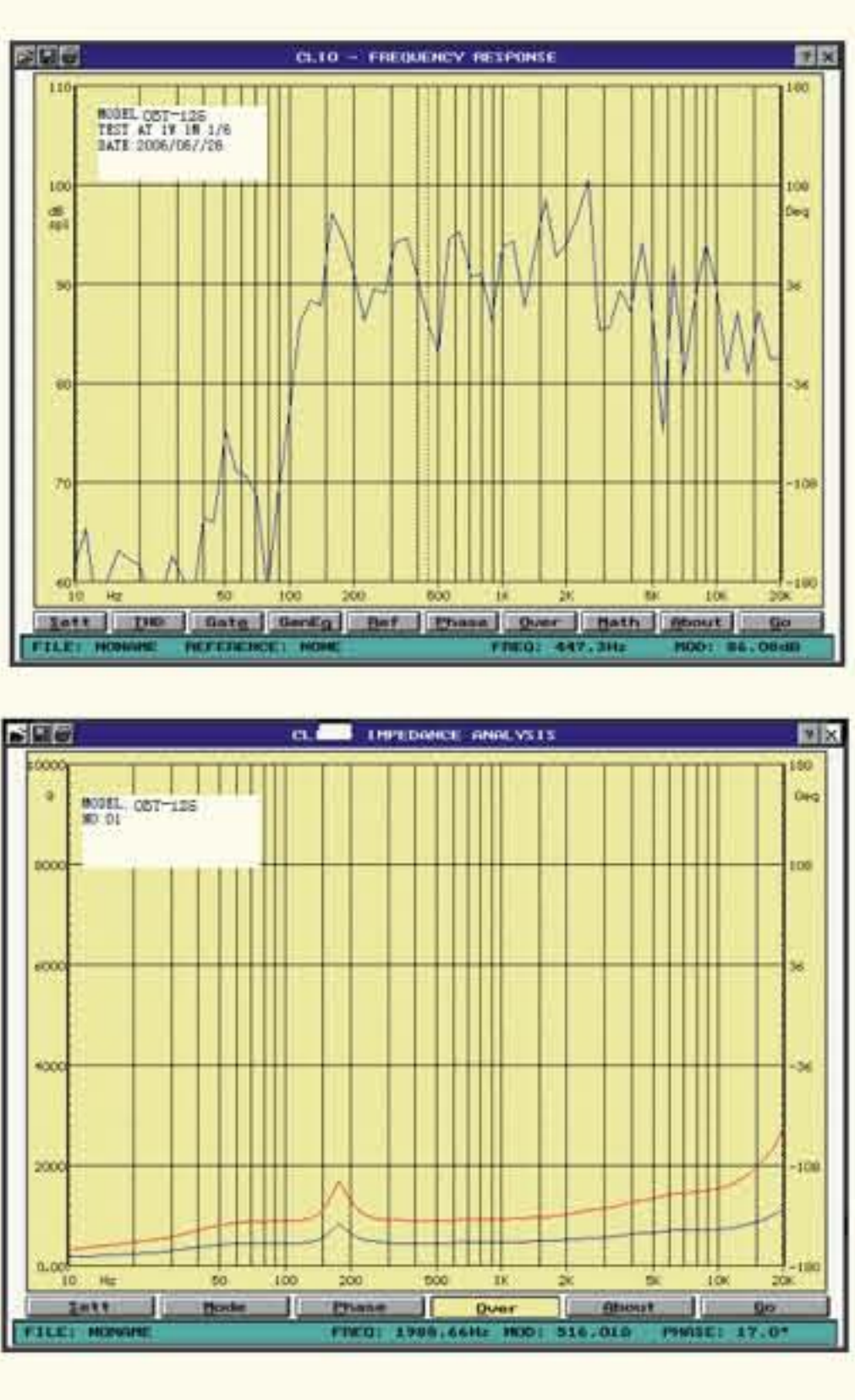

OBT-127

